

# Refrigerant Pump

Original Operating Manual Series CAMR

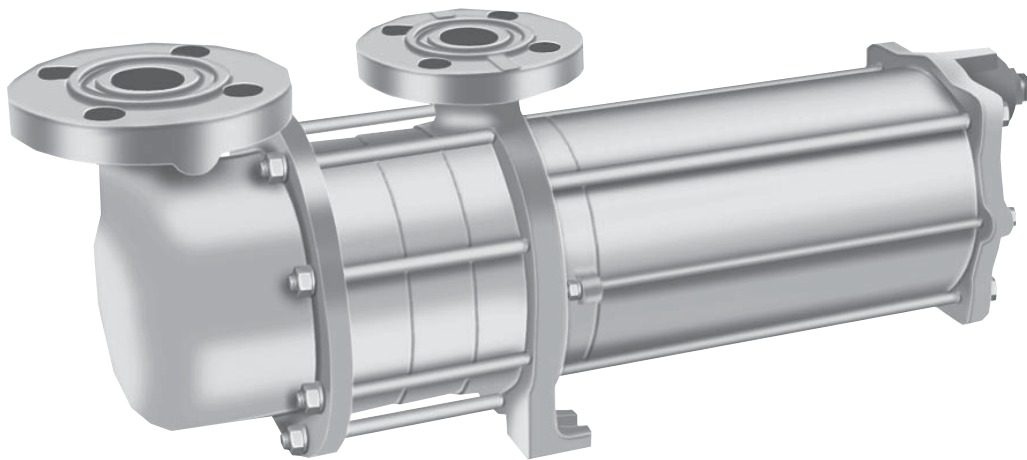

Edition BA-2014.12  
Revision 1  
Print no. 1.4 EN

**HERMETIC-Pumpen GmbH**  
Gewerbestrasse 51  
D-79194 Gundelfingen,  
Germany  
phone +49 7615830-0  
fax +497615830-280  
hermetic@hermetic-pumpen.com  
<http://www.hermetic-pumpen.com>

We reserve the right to make technical changes.



## Table of contents

1	About this operating manual .....	6
1.1	Target groups .....	6
1.2	Other applicable documents .....	6
1.3	Warnings and symbols .....	7
2	Safety .....	8
2.1	Intended use .....	8
2.1.1	Prevention of obvious misuse (examples) .....	8
2.1.2	Residual risks and measures .....	9
2.2	General safety instructions .....	10
2.2.1	Product safety .....	10
2.2.2	Obligations of the operating company .....	10
2.2.3	Obligations of personnel .....	11
3	Layout and Function .....	12
3.1	Label .....	12
3.2	Layout .....	14
4	Transport, Storage and Disposal .....	15
4.1	Transport .....	15
4.1.1	Unpacking and inspection on delivery .....	15
4.1.2	Lifting .....	15
4.2	Treatment for storage .....	16
4.3	Storage .....	16
4.4	Disposal .....	16
5	Installation and connection .....	17
5.1	Preparing the setup .....	17
5.1.1	Checking the ambient conditions .....	17
5.1.2	Preparing the installation site .....	17
5.1.3	Preparing the foundation .....	17
5.1.4	Preparing the machine .....	17
5.2	Planning the piping .....	18
5.2.1	Specifying supports and flange connections .....	18
5.2.2	Specifying nominal diameters .....	18
5.2.3	Specifying pipe lengths .....	19
5.2.4	Supply flow speed .....	19
5.2.5	Optimizing cross-section and direction changes .....	19
5.2.6	Providing safety and control devices (recommended) .....	20
5.2.7	Making provisions for isolating and shutting off pipes .....	20
5.2.8	Allow measurements of the operating conditions .....	20
5.2.9	Installation Recommendations .....	20
5.3	Connecting the pipes .....	23

5.3.1	Keeping the piping clean .....	23
5.3.2	Mounting the supply pipe .....	23
5.3.3	Installing the discharge pipe .....	23
5.3.4	Ensure stress-free pipe connections .....	24
5.4	Electrical connection .....	24
5.4.1	Providing a motor protection switch .....	24
5.4.2	Connecting the motor .....	24
6	Operation .....	25
6.1	Putting the machine into service for the first time.....	25
6.1.1	Identifying the machine type .....	25
6.1.2	Checking the shutdown period .....	25
6.1.3	Filling up and venting.....	25
6.1.4	Checking the sense of rotation .....	25
6.1.5	Turning On.....	26
6.1.6	Switching off .....	26
6.2	Operating.....	27
6.2.1	Turning on .....	27
6.2.2	Switching off .....	27
6.3	Shutting down the machine .....	28
6.4	Start-up following a shutdown period .....	28
6.5	Operating the stand-by pump .....	28
7	Maintenance .....	29
7.1	Inspections .....	29
7.2	Repairs.....	30
7.2.1	Dismounting .....	31
7.2.2	Returning the pump to the manufacturer .....	33
7.2.3	Installing.....	33
7.3	Ordering spare parts.....	34
8	Troubleshooting .....	35
8.1	Malfunctions.....	35
8.2	Fault rectification .....	35
9	Appendix .....	38
9.1	Recommended spare parts .....	38
9.2	Technical specifications.....	38
9.2.1	Ambient conditions.....	38
9.2.2	Sound pressure level.....	38
9.3	Safety certificate.....	39
9.4	Declarations in accordance with the EC Machinery Directive .....	40
9.4.1	Declaration of conformity in accordance with the EC Machinery Directive .....	40

## List of figures

Fig. 1:	Pump type label (on the name plate) .....	12
Fig. 2:	Motor type label (on the name plate) .....	12
Fig. 3:	Name plate (example) .....	13
Fig. 4:	CAMR layout (example CAMR 2/3) .....	14
Fig. 5:	Fastening the lifting gear to the pump unit .....	15
Fig. 6:	Fastening lifting gear to pump unit with base plate .....	15
Fig. 8:	Arrangement of vortex breakers at the vessel outlet.....	20
Fig. 9:	Vessel inlet/vessel outlet arrangement.....	21
Fig. 10:	Vessel inlet/vessel outlet arrangement.....	21
Fig. 11:	Parallel operation arrangement .....	21
Fig. 12:	Slow pressure/temperature drop.....	21
Fig. 13:	Automatic venting (single pump - parallel pumps).....	22
Fig. 14:	Dismounting the carbon bearing.....	32
Fig. 15:	Safety certificate.....	39
Fig. 16:	Declaration of conformity in accordance with the EC Machinery Directive .....	40

## List of tables

Tab. 1: Target groups and their duties .....	6
Tab. 2: Other applicable documents and their purpose.....	6
Tab. 3: Warnings and consequences of disregarding them.....	7
Tab. 4: Symbols and their meaning .....	7
Tab. 5: Measures after longer storage/shutdown periods .....	17
Tab. 6: Measures to be taken if the machine is shut down .....	28
Tab. 7: Measures depending on the behavior of the pumped liquid .....	28
Tab. 8: Measures for return .....	33
Tab. 9: Malfunction/number assignment.....	35
Tab. 10: Fault table.....	37
Tab. 11: Recommended spare parts.....	38

# 1 About this operating manual

This manual:

- Is part of the machine
- Applies to all pump series listed
- Describes safe and appropriate operation during all operating phases

It is strictly prohibited to copy all or part of these instructions, to spread or to use them without authorization for competitive purposes or to release them to third parties.

## 1.1 Target groups

Target group	Duty
Operating company	<ul style="list-style-type: none"> <li>▶ Keep this manual available at all times at the site where the equipment is operated, even during later use.</li> <li>▶ Ensure that personnel read and follow the instructions in this manual and the other applicable documents, especially all safety instructions and warnings.</li> <li>▶ Observe any additional rules and regulations referring to the system</li> </ul>
Qualified personnel, fitter	<ul style="list-style-type: none"> <li>▶ Read, observe and follow this manual and the other applicable documents, especially all safety instructions and warnings.</li> </ul>



Tab. 1: Target groups and their duties

## 1.2 Other applicable documents



Document	Purpose
Tightening torques	Installation of the machine
Performance curve	Operating limits
Declaration of conformity	Legally binding confirmation that the machine fulfills all requirements of the applicable EC guideline(s) (→ 9.4 Declarations in accordance with the EC Machinery Directive, page 40).
Dimensional drawing	Setup dimensions, connection dimensions, etc.
Brochure	Technical specifications, operating limits
Parts list, sectional drawing	Ordering spare parts
Maximum support load table	Maximum permissible forces and torques at the supports
Technical specification	Technical specifications, conditions of operation
Supplier documentation	Technical documentation for parts supplied by subcontractors

Tab. 2: Other applicable documents and their purpose

### 1.3 Warnings and symbols

Warning	Risk level	Consequences of disregard
 <b>DANGER</b>	Immediate acute risk	Death, serious bodily harm
 <b>WARNING</b>	Immediate acute risk	Death, serious bodily harm
 <b>CAUTION</b>	Potentially hazardous situation	Minor bodily harm
<b>NOTE</b>	Potentially hazardous situation	Material damage

Tab. 3: Warnings and consequences of disregarding them

Symbol	Meaning
	<ul style="list-style-type: none"> <li>▶ Safety warning sign</li> <li>▶ Take note of all information highlighted by the safety warning sign and follow the instructions to avoid injury or death.</li> </ul>
▶	Instruction
1. , 2. , ...	Multiple-step instructions
✓	Precondition
→ →	Cross-reference
	Information, recommendation

Tab. 4: Symbols and their meaning

## 2 Safety



The manufacturer does not accept any liability for damage resulting from disregard of any parts of this documentation.

### 2.1 Intended use

- Only use the machine within the limits set by the technical specifications (→ technical specification).
- Liquid pumped
  - Only use the machine for pumping the agreed liquids (→ technical specification).
  - Observe the specified physical properties of the pumped liquids, such as temperature, density, viscosity, specific heat and vapor pressure.
- Electric motor
  - Only operate the electric motor with the designated voltage and frequency (→ technical specification).
- Conditions of use
  - Suction head, system pressure and flow rate must remain within the specified limits (→ technical specification).

#### 2.1.1 Prevention of obvious misuse (examples)

- Pumping liquids containing solids is not permitted.
- Pumping liquids containing impurities is not permitted. It can cause cavitation and damage to the pump.
- Do not use in explosion-hazard areas.
- Avoid dry-running
  - Dry running causes severe damage, such as destruction of the sleeve bearings and pump components, within a few seconds.
  - Ensure that the pump is always filled with pumping liquid.
  - Bleed the pump completely before the initial start-up.
- Avoiding cavitation
  - Comply with the minimum suction head (→ 5.2.3 Specifying pipe lengths, page 19).
  - Fully open the suction-side valve and do not use it to adjust the flow.
  - Monitor the suction-side filter.
  - Ensure that the flow rate remains within the specified limits (→ technical specification).
- Avoiding overheating
  - Do not operate the pump while the pressure-side fitting is closed.
  - Observe the minimum flow rate (→ technical specification).
- Avoiding overloading
  - Observe the maximum flow rate (→ technical specification).
- Remove covers, transport and sealing covers before installation.



### 2.1.2 Residual risks and measures

Residual risk	Measures by the operating company
Cuts while working without personal protective equipment.	Observe warnings in the operating manual. Training for personnel. Provide and use personal protective equipment.
Electric shock: <ul style="list-style-type: none"> <li>• Motor not properly electrically connected</li> <li>• Machine is not, or incorrectly, grounded</li> <li>• Access by unauthorized persons</li> </ul>	Observe warnings in the operating manual. Training for personnel. Prevent access by unauthorized persons.
Burns, frostbite, crushing <ul style="list-style-type: none"> <li>• Machine is insufficiently protected from accidental contact</li> <li>• Access by unauthorized persons</li> </ul>	Observe warnings in the operating manual. Training for personnel. Prevent access by unauthorized persons. Install protection against accidental contact.
Injuries due to escaping pumped liquids when not used in accordance with specifications.	Observe warnings in the operating manual. Training for personnel. Prevent access by unauthorized persons. Provide and use personal protective equipment.

## 2.2 General safety instructions



Note the following regulations before carrying out any work.

### 2.2.1 Product safety

The machine has been constructed according to the latest technology and recognized technical safety rules. Nevertheless, operation of the machine can still put the life and health of the user or third parties at risk, damage the machine or other property.

- Only operate the machine when in perfect technical condition and only use as intended, staying aware of safety and risks, and in adherence to the instructions in this manual.
- Keep this manual and all other applicable documents complete, legible and accessible to personnel at all times.
- Refrain from any procedures and actions that would pose a risk to personnel or third parties.
- In the event of any safety-relevant malfunctions, shut down the machine immediately and have the malfunction corrected by appropriate personnel.
- In addition to the entire documentation for the product, comply with statutory or other safety and accident prevention regulations and the applicable standards and guidelines in the country where the machine is being used.

### 2.2.2 Obligations of the operating company

#### Safety-conscious operation

- Only operate the machine when in perfect technical condition and only use as
- intended, staying aware of safety and risks, and in adherence to the instructions in this manual.
- Ensure that the following safety aspects are observed and monitored:
  - Adherence to intended use
  - Statutory or other safety and accident prevention regulations
  - Safety regulations governing the handling of hazardous substances
  - Applicable standards and guidelines in the country where the machine is operated
- Provide personal protective equipment.

#### Qualified personnel

- Make sure all personnel entrusted with work on the machine have read and understood this manual and all other applicable documents, especially the safety, maintenance and repair information, before they start any work.
- Organize responsibilities, areas of competence and the supervision of personnel.

- Have all work in all operating phases carried out by specialist technicians only.
- Make sure that trainee personnel only work on the machine under supervision of specialist technicians.

#### **Safety equipment**

- Provide the following safety equipment and verify its functionality:
  - for hot, cold surfaces: protection against accidental contact for the machine, provided by the operating company
  - ensure appropriate grounding

#### **Warranty**

- Obtain the manufacturer's approval prior to carrying out any modifications, repairs or alterations during the warranty period.
- Only use genuine parts or parts that have been approved by the manufacturer.

### **2.2.3 Obligations of personnel**

- Observe all warnings on the machine and ensure they are legible.
- Do not remove protection against accidental contact for hot and cold surfaces during operation.
- Use personal protective equipment whenever necessary.
- Only carry out work on the machine while it is not running.
- Isolate the motor from its supply voltage and secure it against being switched back on again when carrying out any fitting or maintenance work.
- Reinstall the safety equipment on the machine according to regulations after any work on the machine.

### 3 Layout and Function

#### 3.1 Label

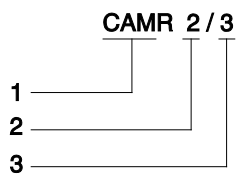

Fig. 1: Pump type label (on the name plate)

- 1 Series
- 2 Size
- 3 Number of stages

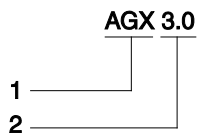
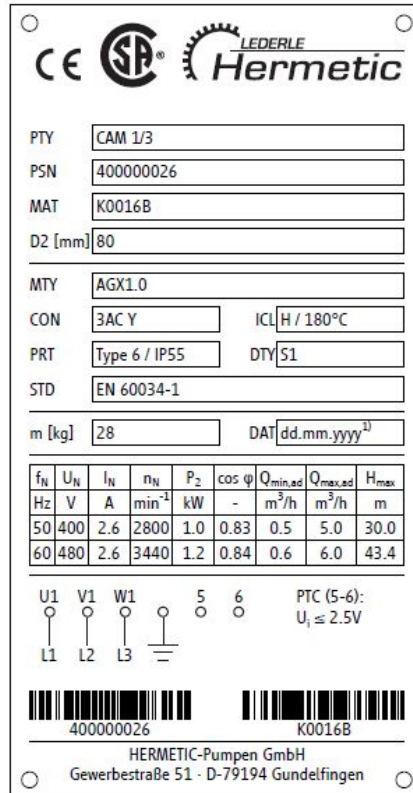



Fig. 2: Motor type label (on the name plate)

- 1 Construction type
- 2 Size



CE  

PTY CAM 1/3  
 PSN 40000026  
 MAT K0016B  
 D2 [mm] 80  
 MTY AGX1.0  
 CON 3AC Y ICL H / 180°C  
 PRT Type 6 / IP55 DTY S1  
 STD EN 60034-1  
 m [kg] 28 DAT dd.mm.yyyy<sup>1)</sup>

f <sub>N</sub>	U <sub>N</sub>	I <sub>N</sub>	n <sub>N</sub>	P <sub>2</sub>	cos φ	Q <sub>min,ad</sub>	Q <sub>max,ad</sub>	H <sub>max</sub>
Hz	V	A	min <sup>-1</sup>	kW	-	m <sup>3</sup> /h	m <sup>3</sup> /h	m
50	400	2.6	2800	1.0	0.83	0.5	5.0	30.0
60	480	2.6	3440	1.2	0.84	0.6	6.0	43.4

U1 V1 W1 5 6 PTC (5-6):  
 L1 L2 L3 U<sub>i</sub> ≤ 2.5V

40000026 K0016B  
 HERMETIC-Pumpen GmbH  
 Gewerbestraße 51 · D-79194 Gundelfingen

Fig. 3: Name plate (example)

PTY	=	Pump type
PSN	=	Equipment no. / Series no.
MAT	=	Material no.
D2	=	Impeller-Ø
MTY	=	Motor type
CON	=	Control
ICL	=	Insulation class
PRT	=	Protection class
DTY	=	Operating mode
STD	=	Standard
M	=	Weight
DAT	=	Date of manufacture
f <sub>N</sub>	=	Nominal frequency
U <sub>N</sub>	=	Nominal voltage
I <sub>N</sub>	=	Nominal current
n <sub>N</sub>	=	Nominal speed
P <sub>2</sub>	=	Nominal capacity
Cos φ	=	Power factor
Q <sub>min ad</sub>	=	Minimum flow rate
Q <sub>max ad</sub>	=	Maximum flow rate
H <sub>max</sub>	=	Maximum conveying height

### 3.2 Layout

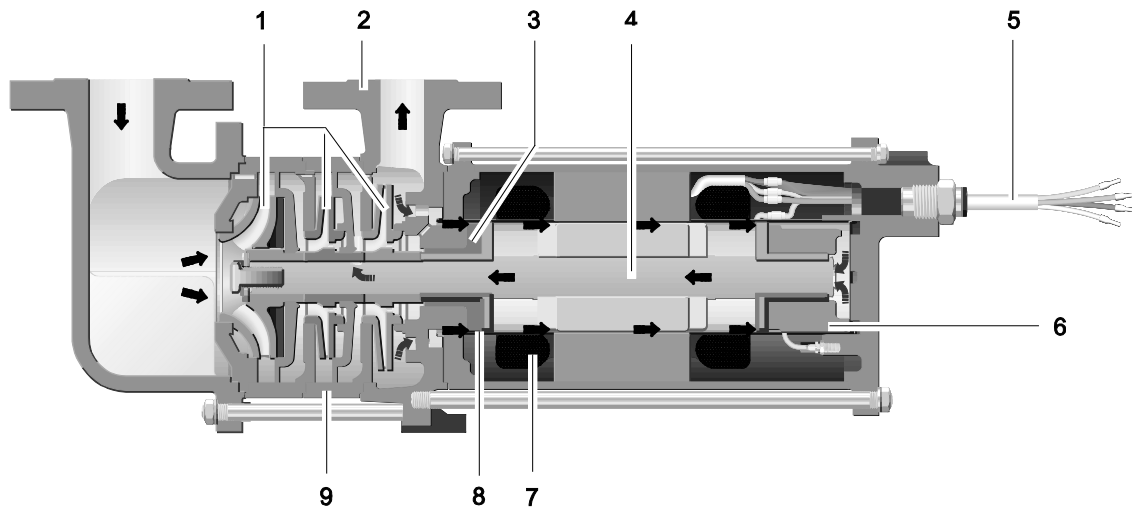

Fig. 4: CAMR layout (example CAMR 2/3)

- 1 Impellers
- 2 Pressure stage
- 3 Front sleeve bearing
- 4 Top shaft
- 5 Connection cable
- 6 Rear sleeve bearing
- 7 Electrical winding
- 8 Stator tube
- 9 Stage casing

## 4 Transport, Storage and Disposal

### 4.1 Transport

Weight specifications(→ 3.1 Label, page 12).

#### 4.1.1 Unpacking and inspection on delivery

1. Unpack the machine on delivery and inspect it for damage during transport.
2. Report any damage during transport to the manufacturer immediately.
3. Dispose of packaging material according to pertinent local regulations.

#### 4.1.2 Lifting



**Death or crushing of limbs may be caused by falling loads!**

- ▶ Use lifting gear appropriate for the total weight to be transported.
- ▶ Fasten the lifting gear as illustrated below.
- ▶ Do not stand under suspended loads.

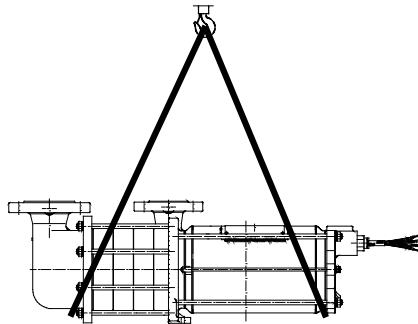

Fig. 5: Fastening the lifting gear to the pump unit

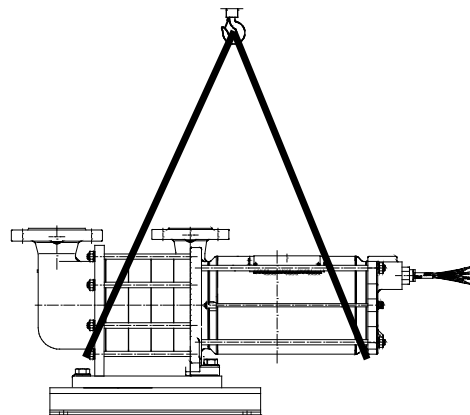

Fig. 6: Fastening lifting gear to pump unit with base plate

- ▶ Lift the unit in an orderly fashion.

## 4.2 Treatment for storage



Not necessary for stainless materials.  
The preservation applied at the plant lasts for 12 months.

### NOTE

- ▶ **Material damage may occur due to inappropriate treatment for storage!**
- ▶ Ensure the machine is treated for storage properly, both inside and outside.

1. Selecting preservatives:
  - Compatible with the machine materials
  - Compatible with the pumped liquid
2. Use the preservative specified by the manufacturer.
3. All bare metal parts should be treated with preservative, inside and outside.

## 4.3 Storage

### NOTE

**Material damage may occur due to inappropriate storage!**

- ▶ Store the machine properly.

1. Close all openings with blank flanges, plugs or plastic covers.
2. Ensure the storage room is:
  - dry
  - frost-free
  - vibration-free
3. Rotate the motor shaft before installing the pump and check that it can move freely.

## 4.4 Disposal



### WARNING

**Risk of poisoning and environmental damage by the pumped liquid or oil!**

- ▶ Use personal protective equipment when carrying out any work on the machine.
- ▶ Prior to the disposal of the machine: Collect and dispose any leaking pumped liquid in accordance with local regulations.

1. Empty the machine completely and clean it.
2. Dispose of the machine in accordance with local regulations.



## 5 Installation and connection

### NOTE

#### Material damage can be caused by dirt!

- ▶ Do not remove any covers, transport and sealing covers until immediately before connecting the pipes to the pump.

### 5.1 Preparing the setup

#### 5.1.1 Checking the ambient conditions

1. Make sure the required ambient conditions are fulfilled (→ 9.2.1 Ambient conditions, page 38).
2. Adhere to system conditions (→ brochure, technical specification).

#### 5.1.2 Preparing the installation site

- ▶ Ensure the installation site meets the following conditions:
  - Machine is freely accessible from all sides
  - There is sufficient space for the installation/removal of the pipes and for maintenance and repair work, especially for the removal and installation of the pump and the motor
  - Machine is not exposed to external vibrations (damage to bearings)

#### 5.1.3 Preparing the foundation

- ▶ Make sure the foundation and surface are:
  - level
  - clean (no oil, dust or other impurities)
  - capable of bearing the weight of the machine unit and all operating forces
  - ensure the machine is stable and cannot tip over

#### 5.1.4 Preparing the machine

- ▶ After longer storage/shutdown periods, perform the following measures:

Storage/shutdown period	Measure
2 Years	▶ If necessary, replace the seals.

Tab. 5: Measures after longer storage/shutdown periods

---

## 5.2 Planning the piping

### 5.2.1 Specifying supports and flange connections

---

#### NOTE

**Material damage may occur due to excessive forces and torques exerted by the piping on the pump!**

- ▶ Do not exceed the permissible values (→ general arrangement drawing with maximum nozzle loads)
- 

1. Calculate the pipe forces, taking every possible operating condition into account:
  - Cold/warm
  - Empty/full
  - Unpressurized/pressurized
  - Positional changes of the flanges
2. Ensure the pipe supports have permanent low-friction properties and do not seize up due to corrosion.

### 5.2.2 Specifying nominal diameters



Keep the flow resistance in the pipes as low as possible.

1. Make sure the nominal suction pipe diameter is  $\geq$  the nominal suction branch diameter.
2. Make sure the nominal vessel outlet diameter is  $\geq$  the nominal outlet flange diameter.

### 5.2.3 Specifying pipe lengths

Calculate the minimum suction head (→technical specification)

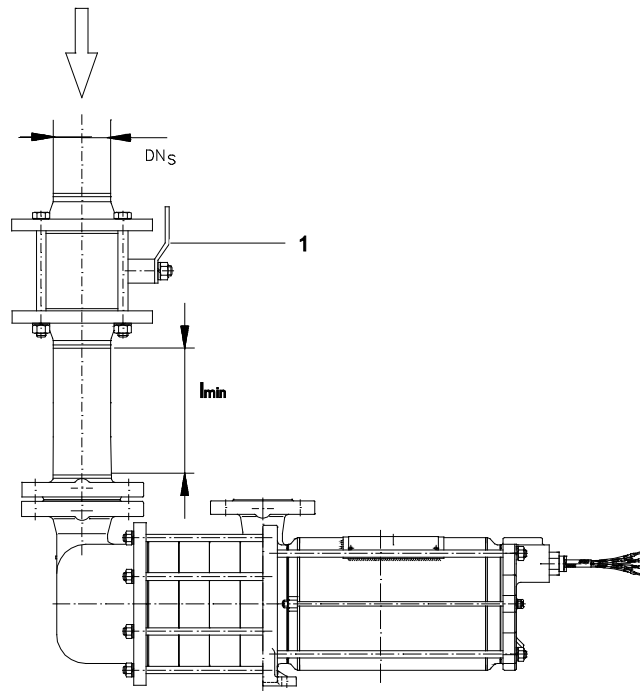

Fig. 7: Supply pipe

- 1  $e_{\min} = \text{NPSHR} + R_z + S$   
 $e_{\min}$  – minimum suction head [m]  
 $R_z$  – resistance of the supply pipe [m]  
 $S$  – additional safety factor [m]
- 2 Maintain the minimum suction head when installing the pump.
- 3  $l_{\min} = 5 \cdot \text{DN}_s$   
 $l_{\min}$  – minimum length of the settling section [mm]  
 $\text{DN}_s$  – supply pipe diameter [mm]
- 4 Maintain the minimum length of the horizontal settling section.



Upstream: Shorter pipes are possible, but may restrict the hydraulic performance and/or lead to cavitation.

### 5.2.4 Supply flow speed

1. Calculate the supply flow speed.  
 – Optimum speed: 0.3 m/s – 0.5 m/s
2. If necessary, adjust the diameter of the supply pipe.

### 5.2.5 Optimizing cross-section and direction changes

1. Avoid bending radii of less than 1.5 times the nominal pipe diameter.
2. Avoid abrupt changes of cross-section along the piping.
3. Lay the supply pipe so that it runs constantly downwards and not horizontally to the supply container.

**5.2.6 Providing safety and control devices (recommended)**

1. Provide a separator in the supply pipe.
2. Provide a vortex breaker in the vessel outlet.
3. Arrange the vessel inlet and outlet at angles to each other.
4. If parallel operation is in use: provide each pump with its own vessel outlet.
5. Ensure that the pressure/temperature in the supply container drops slowly.

**5.2.7 Making provisions for isolating and shutting off pipes**



For maintenance and repair work.

- ▶ Provide shut-off devices in the supply pipes and vessel outlets.

**5.2.8 Allow measurements of the operating conditions**

1. Provide manometers for pressure measurements in the supply pipes and vessel outlets.
2. Provide for pump-side / pipe-side temperature measurements.

**5.2.9 Installation Recommendations**

**Avoiding cavitation**

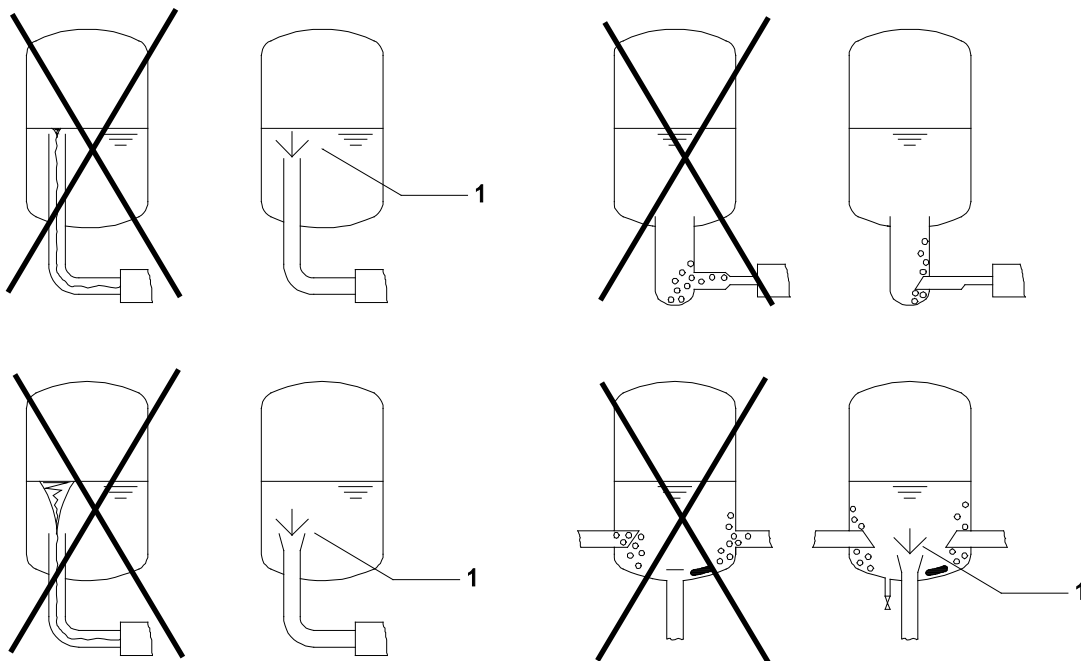

Fig. 8: Arrangement of vortex breakers at the vessel outlet

1 Vortex breaker

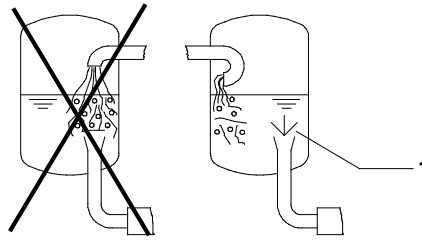

Fig. 9: Vessel inlet/vessel outlet arrangement

1 Vortex breaker

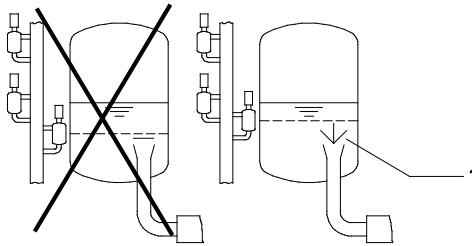

Fig. 10: Vessel inlet/vessel outlet arrangement

1 Vortex breaker

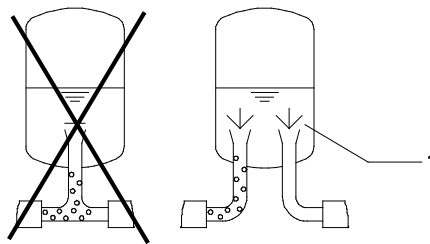

Fig. 11: Parallel operation arrangement

1 Vortex breaker

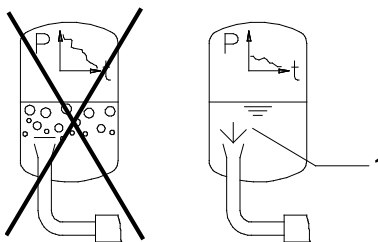

Fig. 12: Slow pressure/temperature drop

1 Vortex breaker

**Automatic venting**

1. Install a non-return valve between the outlet flange and the gate valve to ensure the medium does not flow back when the pump is switched off.
2. Provide a bypass pipe to enable venting:
  - guide the bypass pipe from the discharge pipe between the pump and non-return valve into the supply container's gas phase.
  - In doing so make sure that there is no non-return valve in the bypass pipe

**PLEASE NOTE**

**Material damage caused by an accumulation of gas!**

- ▶ Make sure that an accumulation of gas is not possible in the suction pipe or valves under any circumstances.
  - Gas bubbles must be able to rise unhindered to the supply container when the pump is switched off.
- ▶ Make sure that larger accumulations of gases are avoided in the discharge pipe between the pump and non-return valve.
  - Installing the non-return valve valve as close as possible after the outlet flange
  - Providing a bypass pipe

3. For parallel operation:
  - Separate supplies for the pumps
  - Separate bypass pipes

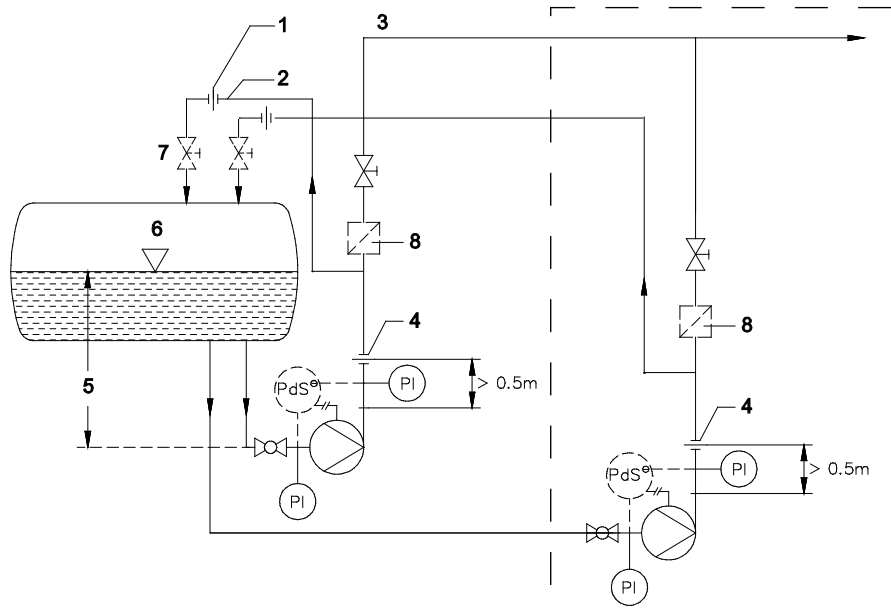

Fig. 13: Automatic venting (single pump - parallel pumps)

- 1 Qmin – orifice (directly in front of gate valve / supply container)
- 2 Bypass pipe
- 3 Consumer
- 4 Qmax – orifice
- 5 Suction head

- 6 Supply container
- 7 Gate valve (directly in front of supply container)
- 8 Non-return valve

## 5.3 Connecting the pipes

### 5.3.1 Keeping the piping clean

---

**NOTE****Material damage may occur due to impurities in the machine!**

- ▶ Ensure no impurities can enter the machine:
  - Flush the pipes so that scales, welding beads and other foreign objects do not damage the machine.
  - If necessary, install a sieve in the supply pipe during the start-up phase.

- 
1. Clean all piping parts and fittings prior to assembly.
  2. Ensure no flange seals protrude inwards.
  3. Remove any blank flanges, plugs, protective foils and/or protective paint from the flanges.

### 5.3.2 Mounting the supply pipe

1. Remove the transport and sealing covers on the machine.
2. Run the pipes with a continuous downwards slope to the pump.
3. Ensure no seals protrude inwards.

### 5.3.3 Installing the discharge pipe

---

**PLEASE NOTE****Damages can result from incorrect connection!**

- ▶ Connect the pipes properly.

- 
1. Remove the transport and sealing covers from the pump.
  2. Installing the discharge pipe:
    - Qmax orifice at least 0.5 m above the outlet flange of the pump
  3. Installing the bypass pipe:
    - in front of the non-return valve in the discharge pipe
    - Run the pipe with a continuous upward slope to the supply container
    - Qmin orifice as close as possible to the supply container
  4. Ensure no seals protrude inwards.

### 5.3.4 Ensure stress-free pipe connections

1. Ensure that
  - the permissible flange forces are not exceeded
  - the pump is not used as an anchor point for pipes
2. When pumping cold / hot liquids, ensure that
  - the pipes have been laid suitably for expansion
  - the pipes have been spring-suspended or expansion joints have been used

## 5.4 Electrical connection



**DANGER**

### Risk of death due to electric shock!

- ▶ Have all electrical work carried out by qualified electricians only.

### 5.4.1 Providing a motor protection switch

- ▶ Provide a motor protection switch in accordance with VDE 0660 with the following specifications:
  - Current rating on the name plate
  - Motor operation type = S1
  - Maximum permissible switch frequency in normal operation = 6 start-ups/ hour
  - Minimum pause between 2 starts = 10 minutes

### 5.4.2 Connecting the motor



Connect the terminals as follows for the correct sense of rotation:

- U1-L1
- V1-L2
- W1-L3.



For motors with rotation monitor (→manual ROMi / ROMe)

1. Connect the motor according to the connection diagram.
2. Ground the motor using the grounding conductor of the cable connection.
  - If available, also ground the motor using the grounding terminal on the rear motor casing cover.
3. Install an EMERGENCY STOP switch.



## 6 Operation

### 6.1 Putting the machine into service for the first time

#### 6.1.1 Identifying the machine type

- ▶ Identify the machine type (→ technical specification).

#### 6.1.2 Checking the shutdown period

- ▶ After a shutdown period of > 2 years (→ 5.1.4 Preparing the machine, page 17).

#### 6.1.3 Filling up and venting



**WARNING**

#### **Risk of injury and poisoning due to hazardous pumped liquids!**

- ▶ Use personal protective equipment when carrying out any work on the machine.
- ▶ Safely collect any leaking pumped liquid and dispose of it in accordance with environmental rules and requirements.

#### **PLEASE NOTE**

#### **Material damage caused by dry running!**

- ▶ Make sure the machine is filled up and bled properly.

1. Open the shut-off devices in the supply pipe and bypass pipe.
2. Fill the pump and the supply pipe with pumped liquid.
3. Wait until the pump casing has cooled to the temperature of the supply container.
4. Make sure that no pipe connections are leaking.

#### 6.1.4 Checking the sense of rotation

1. Switch on the motor.
2. Check the operating parameters or rotary field of the motor.



**DANGER**

#### **Risk of death due to electric shock!**

- ▶ Have all electrical work carried out by qualified electricians only.

3. In the event of deviating operational parameters or incorrect field of rotation: swap two phases.
4. Re-establish the electrical connections of the motor.

### 6.1.5 Turning On

- ✓ Machine correctly set up and connected
- ✓ All connections stress-free and sealed
- ✓ All safety equipment installed and tested for functionality
- ✓ Machine properly prepared, filled up, and bled



#### Risk of injury due to running machine!

- ▶ Do not touch the running machine.
- ▶ Do not carry out any work on the running machine.



#### Risk of injury and poisoning due to pumped liquid spraying out!

- ▶ Use personal protective equipment when carrying out any work on the machine.

### PLEASE NOTE

#### Material damage caused by dry running!

- ▶ Make sure the pump is filled and bled properly.
- ▶ Observe the permissible flow rate (→ technical specification, performance curve).

### NOTE

#### Risk of cavitation when throttling down the supply flow rate!

- ▶ Fully open the supply-side fitting and do not use it to adjust the delivery flow.
- ▶ Observe the permissible flow rate (→ technical specification).

### NOTE

#### Material damage caused by overheating!

- ▶ Do not operate the pump while the pressure-side fitting is closed.
- ▶ Observe the permissible flow rate (→ technical specification).

1. Open the supply-side fitting.
2. Close the pressure-side fitting.
3. Switch on the motor and make sure it is running smoothly.
4. Once the motor has reached its nominal speed, open the pressure-side fitting slowly until the operating point is reached.
5. After the first load under pressure and at operating temperature, check that the machine is not leaking.

### 6.1.6 Switching off

1. Switch off the motor.
2. Check all tie bolts and tighten them if necessary.

## 6.2 Operating

### 6.2.1 Turning on

- ✓ Pump initially put into service properly
- ✓ Pump prepared, filled and bled properly



**DANGER**

#### **Risk of injury due to running machine!**

- ▶ Do not touch the running machine.
- ▶ Do not carry out any work on the running machine.



**DANGER**

#### **Risk of injury and poisoning due to pumped liquid spraying out!**

- ▶ Use personal protective equipment when carrying out any work on the machine.

**NOTE**

#### **Risk of cavitation when throttling down the supply flow rate!**

- ▶ Fully open the supply-side fitting and do not use it to adjust the delivery flow.

**NOTE**

#### **Material damage caused by overheating!**

- ▶ Do not operate the pump while the pressure-side fitting is closed.
- ▶ Observe the permissible flow rate (→ technical specification).

1. Open the supply-side fitting.
2. Close the pressure-side fitting.
3. Switch on the motor and make sure it is running smoothly.
4. Once the motor has reached its nominal speed, open the pressure-side fitting slowly until the operating point is reached.

### 6.2.2 Switching off

- ✓ Pressure-side fitting closed (recommended)



**WARNING**

#### **Risk of injury due to cold surfaces!**

- ▶ Use personal protective equipment when carrying out any work on the machine.
- ▶ Switch off the motor.

### 6.3 Shutting down the machine



**Risk of injury and poisoning due to hazardous pumped liquids!**

- ▶ Safely collect any leaking pumped liquid and dispose of it in accordance with environmental rules and requirements.

- ▶ Take the following measures whenever the machine is shut down:

Machine is	Measure
...shut down for a prolonged period	▶ Take measures appropriate to the pumped liquid (→ 6.2.1 , page 27).
...emptied	▶ Close the suction-side valve and pressure-side fittings.
...dismounted	▶ Isolate the motor from its power supply and secure it against unauthorized switch-on.
...put into storage	▶ Follow the storage instructions (→ 4.3 Storage, page 16).

Tab. 6: Measures to be taken if the machine is shut down

Behavior of the pumped liquid	Duration of shutdown (depending on process)	
	Short	Long
Remains liquid, non-corrosive	–	–
Remains liquid, corrosive	–	<ul style="list-style-type: none"> <li>▶ Empty the pump and containers.</li> <li>▶ Treat the pump and containers with preservative.</li> </ul>

Tab. 7: Measures depending on the behavior of the pumped liquid

### 6.4 Start-up following a shutdown period

In the event of shutdown periods of more than 2 years:

- (→ 5.1.4 Preparing the machine, page 17).
- Carry out all steps as for the initial start-up (→ 6.1 Putting the machine into service for the first time, page 25).

### 6.5 Operating the stand-by pump

1. Preparing the stand-by pump:
  - Putting the pump into service for the first time
  - (→ 6.1 Putting the machine into service for the first time, page 25).
  - Filling and bleeding the stand-by pump.
2. Using the stand-by pump (→ 6.2.1 , page 27).

## 7 Maintenance

Trained service technicians are available for fitting and repair work. Present a pumped medium certificate (DIN safety data sheet or safety certificate) when requesting service.

### 7.1 Inspections



The inspection intervals depend on the operational strain on the machine.



**DANGER**

#### **Risk of injury due to running machine!**

- ▶ Do not touch the running machine.
- ▶ Do not carry out any work on the running machine.



**WARNING**

#### **Risk of injury and poisoning due to hazardous pumped liquids!**

- ▶ Use personal protective equipment when carrying out any work on the pump.

1. Check at appropriate intervals:
  - Adhere to the minimum and maximum flow rates (→ technical specification)
  - Normal operating conditions unchanged
2. For trouble-free operation, always ensure the following:
  - Minimum suction head
  - No dry running
  - No leaks
  - No cavitation (max. pressure difference between suction and outlet flanges)
  - Open gate valves on supply side
  - No unusual running noises or vibrations

---

## 7.2 Repairs

---



**DANGER**

**Risk of injury due to running machine!**

- ▶ Do not touch the running machine.
  - ▶ Do not carry out any work on the running machine.
  - ▶ Isolate the motor from its supply voltage and secure it against being switched back on again when carrying out any fitting or maintenance work.
- 



**DANGER**

**Risk of death due to electric shock!**

- ▶ Have all electrical work carried out by qualified electricians only.
- 



**WARNING**

**Risk of injury and poisoning due to hazardous pumped liquids and hot or cold components!**

- ▶ Use personal protective equipment for all tasks on the machine.
  - ▶ Prior to all tasks, allow pump and motor to cool down / warm up to ambient temperature.
  - ▶ Ensure that the pump is de-pressurized.
  - ▶ Drain the machine, safely collect pumped liquid, and dispose of it in an environmentally-responsible manner.
- 



**WARNING**

**Risk of injury during maintenance work!**

- ▶ Secure the pressure-side valve against unintentional opening.
  - ▶ Wear protective gloves, components could have very sharp edges.
-

## 7.2.1 Dismounting

### NOTE

**Material damage may occur due to inappropriate dismantling!**

- ▶ Warm up immobile bearing sleeves.

### Preparations for dismounting

- ✓ Machine unpressurized
- ✓ Machine completely empty, flushed and decontaminated
- ✓ Electrical connections disconnected and motor secured against being switched on again
- ✓ Machine de-iced
- ✓ Manometer lines, manometer and holdings dismantled



In production, the machines are constructed according to a standard process. The insert unit can be removed without removing the volute casing and piping.

- ▶ When dismounting, observe the following:
  - Mark the precise orientation and position of all components before dismantling them.
  - Dismount components concentrically without canting.

### Dismount the pump and motor part:



For the designations and positions of the components (→ sectional drawing). Mark the position of the suction casing **106**, stage casing **108** and pump housing **101**.

Mark the position of the impellers **230**, stage casing **108** and vane inserts **174**.

1. Loosen and remove the hex nuts **920.01** and split washers **930.1**.
2. Pull the suction casing **106** and inlet ring **131** forward and off.
3. Bend up the locking plate **931.1** and remove the hex bolt **906** and tension disc **552.1**.
4. Pull off the impeller **230.1**, stage casing **108** and vane insert **174.2** without misaligning the motor shaft **819** and remove the key **940.1**.
5. Repeat step 4 until all the stages have been removed.
6. Loosen and remove the hex nuts **920.2** and split washers **930.9**.
7. Pull the stator completely out of the pump casing.
8. Pull the motor shaft **819** out of the pump casing.
9. Pull off the bearing bush **545.1** with the bearing sleeve **529.1** and engine shaft **819**.
10. Remove the snap ring **932.1** and pull the bearing sleeve **529.2** off the motor shaft **819**.

11. To dismantle the motor-side carbon bearing **545.2** (only for motors AGX 3.0, 4.5 and 6.5):
  - Loosen the stator screw **900.3**.

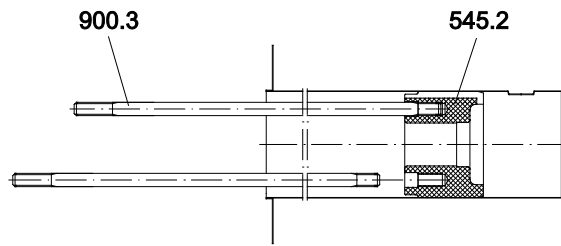

Fig. 14: Dismounting the carbon bearing

Dismounting the stator:

1. Open nut **920.12**, remove clamp screw **900.5**.
2. Remove cover for motor casing **160**.
  - When doing this, label the electric supply lines and disconnect at the connection point.
3. Press out the stator tube **816** out of the stator in the direction of the pump.
4. Remove the cover for motor casing **812.1** from the motor casing **811**.
5. Inspect the stator winding for possible damage:
  - If necessary, replace the stator or rewind it.



### 7.2.2 Returning the pump to the manufacturer

- ✓ Pump unpressurized
  - ✓ Pump completely empty
  - ✓ Secure motor against being switched on again
  - ✓ Pump de-iced
  - ✓ Manometer lines, manometer and holdings dismantled
1. Enclose a truthful and fully completed document of compliance when returning pumps or components to the manufacturer (→ 9.3 Safety certificate, page 39).
  2. Take necessary measures, depending on the required repair work, as listed in the table below when returning the pump to the manufacturer.

Repairs	Measure for return
...at the customer's premises	▶ Return the defective component to the manufacturer.
...at the manufacturer's premises	▶ Flush the pump and decontaminate it if it was used for hazardous pumped liquids. ▶ Return the complete pump unit (not disassembled) to the manufacturer.
...at the manufacturer's premises for warranty repairs	▶ Only in the event of hazardous pumped liquid: flush and decontaminate the pump. ▶ Return the complete pump unit (not disassembled) to the manufacturer.

Tab. 8: Measures for return

### 7.2.3 Installing

#### Preparations for mounting

1. Observe the following during the installation:
  - Replace worn parts with genuine spare parts.
  - Replace seals.
  - Maintain the prescribed tightening torques (→ 1.2 Other applicable documents, page 6).
  - Reinstall the components concentrically and straight in accordance with the marks applied.
2. Clean all parts. Do not remove any markings that may have been attached.
3. Mount the machine (→ sectional drawing). Mounting is conducted in reverse order to dismantling. The following sections detail the particular features of mounting.

---

## Installing

---

### NOTE

#### Material damage due to inappropriate mounting!

- ▶ Ensure that one partial current drill hole is assigned at the top of the bearing carrier **381**.

- 
1. With new bearing bushes **545.1/2** bearing sleeves **529.1/2** make sure:
    - That the cylindrical pin **562.1–3** is adjusted correctly
    - Groove in carbon bearing and notch flush in stator tube are aligned (the bearing can otherwise not be fully inserted).
  2. Secure impeller nut **922** with locking plate **931.1**.

#### Completing assembly

- ▶ Check the machine (→ technical specification):
  - Compressive strength
  - Leak proofness

## 7.3 Ordering spare parts



For trouble-free replacement in the event of faults, we recommend keeping entire insert units or spare pumps available on site.

The application guidelines conforming to DIN 24296 recommend provisioning for two years of continuous use (→ parts list).

- ▶ Have the following information ready to hand when ordering spare parts (→ name plate):
  - Short description of the pump
  - Equipment number
  - Year of manufacture
  - Part number
  - Designation
  - Quantity

## 8 Troubleshooting

### 8.1 Malfunctions

Possible malfunctions are identified by a number in the following table. This number identifies the respective cause and remedy in the troubleshooting list.

Malfunction	Number
Machine not pumping	1
Pumping rate insufficient	2
Pumping rate excessive	3
Pumping pressure insufficient	4
Pumping pressure excessive	5
Machine running roughly	6
Sleeve bearings temperature too high	7
Machine leaking	8
Excessive motor power uptake	9

Tab. 9: Malfunction/number assignment

### 8.2 Fault rectification

If malfunctions occur which are not specified in the following table or cannot be traced back to the specified causes, please consult the manufacturer.

Malfunction number									Cause	Elimination
1	2	3	4	5	6	7	8	9		
X	X	–	X	–	X	–	–	–	Supply pipe or pump blocked or encrusted	▶ Clean the supply pipe or pump.
X	X	–	X	–	X	–	–	–	Gas sucked into pump	▶ Seal the source of malfunction.
X	X	–	X	–	X	–	–	–	Excessive gas proportion: Pump is cavitated	▶ Consult the manufacturer.
X	X	–	X	–	X	–	–	–	Pump running in the wrong rotational direction	▶ Swap any two phases at the motor.
X	X	–	X	–	X	–	–	–	Impeller out of balance or blocked	▶ Dismount the pump and inspect it for dry-running damage. ▶ Clean the impeller.
X	X	–	–	X	X	–	–	–	Discharge pipe blocked	▶ Clean the discharge pipe.
X	X	–	X	–	–	–	–	–	Motor speed too low	▶ Compare the required motor speed with the specifications on the pump name plate. Replace the motor, if necessary. ▶ Increase the motor speed if speed control is available.

Malfunction number									Cause	Elimination
1	2	3	4	5	6	7	8	9		
X	-	-	-	-	-	-	-	-	Transport and sealing cover still in place	<ul style="list-style-type: none"> <li>▶ Remove the transport and sealing cover.</li> <li>▶ Dismantle the machine and check for dry-run damage.</li> </ul>
X	-	-	-	-	-	-	-	-	Supply pipe and/or discharge pipe closed by fitting	<ul style="list-style-type: none"> <li>▶ Open the fitting.</li> </ul>
X	-	-	-	-	X	-	-	-	Supply pipe and machine bled incorrectly or not filled completely	<ul style="list-style-type: none"> <li>▶ Fill up the machine and/or pipe completely and bleed them.</li> </ul>
X	-	-	-	-	X	-	-	-	Supply pipe contains gas pockets	<ul style="list-style-type: none"> <li>▶ Install the fitting for venting.</li> <li>▶ Correct the piping layout.</li> </ul>
-	X	-	X	-	-	-	-	-	Geodetic differential head and/or pipe flow resistance too high	<ul style="list-style-type: none"> <li>▶ Remove sediments from the pump and/or discharge pipe.</li> <li>▶ Install a larger impeller and consult the manufacturer.</li> </ul>
-	X	-	X	-	-	-	-	-	Supply pipe not completely open	<ul style="list-style-type: none"> <li>▶ Open the fitting.</li> </ul>
-	X	-	X	-	X	-	-	-	Hydraulic parts of the machine contaminated, clotted or encrusted	<ul style="list-style-type: none"> <li>▶ Dismantle the machine.</li> <li>▶ Clean the parts.</li> </ul>
-	X	-	X	-	X	-	-	-	Cross section of supply pipe too narrow	<ul style="list-style-type: none"> <li>▶ Increase the cross-section.</li> <li>▶ Remove any encrustations from the supply pipe.</li> <li>▶ Open the fitting completely.</li> </ul>
-	X	-	X	-	X	-	-	-	NPSHR is greater than NPSH	<ul style="list-style-type: none"> <li>▶ Increase the suction head.</li> <li>▶ Consult the manufacturer.</li> </ul>
-	X	-	X	-	X	-	-	-	Pumped liquid temperature too high: Pump is cavitated	<ul style="list-style-type: none"> <li>▶ Increase the suction head.</li> <li>▶ Lower the temperature.</li> <li>▶ Consult manufacturer.</li> </ul>
-	X	-	X	-	X	-	-	-	Pump parts worn	<ul style="list-style-type: none"> <li>▶ Replace the worn pump parts.</li> </ul>
-	X	-	X	-	X	-	-	X	Motor running on 2 phases	<ul style="list-style-type: none"> <li>▶ Check the fuse and replace it if necessary.</li> <li>▶ Check the cable connections and insulation.</li> </ul>
-	X	X	X	X	-	-	-	X	Density, specific heat capacity, vapour pressure or viscosity of the pumped liquid outside the range specified for the pump	<ul style="list-style-type: none"> <li>▶ Consult the manufacturer.</li> </ul>
-	X	-	-	X	X	-	-	-	Pressure-side fitting not opened wide enough	<ul style="list-style-type: none"> <li>▶ Open the pressure-side fitting.</li> </ul>

Malfunction number									Cause	Elimination
1	2	3	4	5	6	7	8	9		
-	-	X	X	-	X	-	-	X	Pressure-side fitting opened too wide	<ul style="list-style-type: none"> <li>▶ Throttle down at the pressure-side fitting.</li> <li>▶ Provide a <math>Q_{max}</math> orifice or flow control valve</li> <li>▶ Rework impeller on the lathe. Consult the manufacturer and adjust the impeller diameter.</li> </ul>
-	-	X	-	-	X	-	-	X	Geodetic differential head, pipe flow resistance and/or other resistance lower than specified	<ul style="list-style-type: none"> <li>▶ Throttle down the flow rate at the pressure-side fitting. Observe the minimum flow rate.</li> <li>▶ Rework impeller on the lathe. Consult the manufacturer and adjust the impeller diameter.</li> </ul>
-	-	X	-	X	X	X	-	X	Motor speed too high	<ul style="list-style-type: none"> <li>▶ Reduce speed with frequency converter.</li> </ul>
-	-	X	-	X	X	-	-	X	Impeller diameter too large	<ul style="list-style-type: none"> <li>▶ Throttle down the flow rate at the pressure-side fitting. Observe the minimum flow rate.</li> <li>▶ Rework impeller on the lathe. Consult the manufacturer and adjust the impeller diameter.</li> </ul>
-	-	-	-	-	X	-	X	X	Machine is deformed	<ul style="list-style-type: none"> <li>▶ Check the pipes and fastening of the machine.</li> </ul>
-	-	-	-	-	-	X	-	-	Not enough pumped liquid, does not correspond to technical specification	<ul style="list-style-type: none"> <li>▶ Add pumped liquid.</li> <li>▶ Comply with the permissible range of application.</li> <li>▶ Consult the manufacturer.</li> </ul>
-	-	-	-	-	-	-	X	-	Tie bolts not tightened properly	<ul style="list-style-type: none"> <li>▶ Tighten the tie bolts.</li> </ul>
-	-	-	-	-	-	-	X	-	Housing seal defective	<ul style="list-style-type: none"> <li>▶ Replace the housing seal.</li> </ul>
-	-	-	-	-	-	-	X	-	Can seal defective	<ul style="list-style-type: none"> <li>▶ Replace the can seal.</li> </ul>

Tab. 10: Fault table

## 9 Appendix

### 9.1 Recommended spare parts



Detailed ordering information (→ parts list).

Item no.	Designation
400.XX	Gaskets
545.01/02	Bearing bushes
529.01/02	Bearing sleeves
758	Strainer insert

Tab. 11: Recommended spare parts

### 9.2 Technical specifications



See technical specification.

#### 9.2.1 Ambient conditions

Ambient temperature: -50 °C to 50 °C



Operation under any other ambient conditions should be agreed with the manufacturer.

#### 9.2.2 Sound pressure level



Sound pressure level calculated according to VDI 3743-1:2003: < 70 dB.

### 9.3 Safety certificate



Please copy this document and send it together with the machine.



## SAFETY / GRAS CERTIFICATE

*All industrial companies are obliged by statutory regulations to protect their employees, other people and the environment from detrimental effects when handling hazardous substances.  
Products and their components are therefore only repaired or inspected if the following declaration is submitted after being filled out properly and completely and signed by an authorized and qualified specialist technician.  
If safety precautions have to be taken by the operating company in spite of the product being completely emptied and cleaned, the required information must be submitted. This document of compliance is part of the repair or inspection order.*

We hereby declare that the returned device and accessories

Pump type, motor type: \_\_\_\_\_

HERMETIC equipment no.: \_\_\_\_\_

is free from substances that may be hazardous to health.  
 was used for \_\_\_\_\_  
 the pump came into contact with the following media which need to be specially marked or contain harmful substances:  
 \_\_\_\_\_

The pump has been completely emptied and thoroughly cleaned on the outside and inside prior to delivery or provision.

it was completely disassembled and cleaned, i.e. the rotor was removed from the stator.  
 No special safety precautions are required for further handling.  
 The following safety precautions are required for flushing media, medium residues and disposal:  
 \_\_\_\_\_  
 \_\_\_\_\_

The following dangers can proceed from medium residues and disposals:

<input type="checkbox"/>		<input type="checkbox"/>		<input type="checkbox"/>	
<input type="checkbox"/>		<input type="checkbox"/>		<input type="checkbox"/>	
<input type="checkbox"/>		<input type="checkbox"/>		<input type="checkbox"/>	<input type="checkbox"/>

material safety data sheet for fluid is attached  
 Approved cleaning products \_\_\_\_\_  will be supplied

We confirm that the above data and information are correct and complete and that dispatch is effected in accordance with the relevant legal provisions.

Company/institute: \_\_\_\_\_  
 Street: \_\_\_\_\_  
 Postal Code, Place: \_\_\_\_\_  
 Phone: \_\_\_\_\_  
 Name: \_\_\_\_\_  
 Position: \_\_\_\_\_

Date: \_\_\_\_\_ Signature: \_\_\_\_\_  
 Company stamp: \_\_\_\_\_

■ HERMETIC-Pumpen GmbH · Gewerbestraße 51 · D-79194 Gundelfingen · phone +49 761 5830-0 · fax +49 761 5830-290 · www.hermetic-pumpen.com  
 Registergericht Freiburg HRB 365 · Geschäftsführer: Nikolaus Krämer (CEO, CCO), Christiane Krämer (CFO), Christian Dalilke (COO), Dr. Roland Krämer (CTO)

Fig. 15: Safety certificate

## 9.4 Declarations in accordance with the EC Machinery Directive

### 9.4.1 Declaration of conformity in accordance with the EC Machinery Directive



The following declaration does not include a serial number or signatures. The original declaration is supplied with the respective machine.



## EC DECLARATION OF CONFORMITY

**according to Directive 2006/42/EC, Annex II Part 1 Section A**

**We hereby declare that the following machinery:**

Denomination: Centrifugal pump with canned motor  
 Pump: CAM x/y  
 Motor: AGXx.y  
 Equipment No.: 41100xxxxx/yyyy-zz  
 Year: 20xx

**complies with all relevant provisions of the following Directives regarding its conceptual design and its construction as well as its state in which it was placed on the market by us:**

- Directive 2006/42/EC of 17 May 2006 on machinery

**Harmonised standards used, as referred to in Article 7(2):**

- EN ISO 12100: 2011-03 Safety of machinery - Basic concepts, general principles for design – Risk assessment and Risk minimization
- EN 809: 1998 Pumps and pump units for liquids - Common safety requirements
- EN 60034-1: 2011-02 Rotating electrical machines - Part 1: Rating and performance
- EN 60034-5: 2007-09 Rotating electrical machines - Part 5: Degrees of protection provided by integral design of rotating electrical machines (IP code) - Classification

**Person authorised to compile the technical file:**  
 Michael Maier, HERMETIC-Pumpen GmbH, Gewerbestrasse 51, D-79194 Gundelfingen

Gundelfingen, 2013-09-19

---

Dr. R. Krämer  
Chief Technical Officer

HERMETIC-Pumpen GmbH - Gewerbestrasse 51 - D-79194 Gundelfingen - phone +49 761 5830-0 - fax +49 761 5830-290 - www.hermetic-pumpen.com  
 Registergericht Freiburg HRB 365 - Geschäftsführer: Nikolaus Krämer (CEO, CCO), Christiane Krämer (CFO), Christian Dalhke (COO), Dr. Roland Krämer (CTO)

Fig. 16: Declaration of conformity in accordance with the EC Machinery Directive